

# DMANL0100001 MANUALE 4HEAT

## 1. SYSTEM STRUCTURE

The structure is comprised of 3 macro-systems:

1. **4HEATMODULE:** hardware device that interfaces the TiEmme elettronica control board with the local Wi-Fi router;
2. **SERVER CLOUD:** web server infrastructure that enables data storage and acts as a star point for remote communication;
3. **4HEAT:** mobile application available from Google Play Store and App Store for free, which allows the user to interface with the heating system;

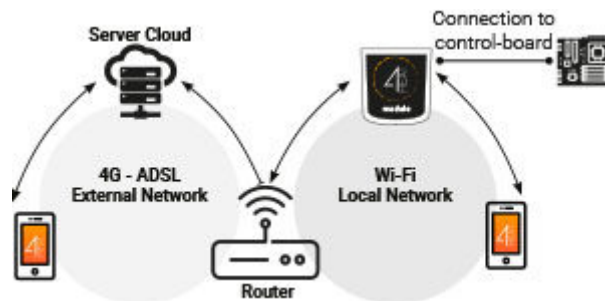

## 2. LOCAL CONNECTION AND REMOTE CONNECTION

### Local connection:

The connection between the 4HEATMODULE and the APP is via the home Wi-Fi network, only if both are connected to the same Wi-Fi network.



### Remote connection:

There is talk of remote connection when at the time of use of the App, the user is away from home. In this case the App takes advantage of the data coverage of your Smartphone and the Cloud Server allows the triangulation of the signal in order to manage the Module from a distance. Remote connection times may vary based on data network traffic, network connection conditions, and traffic to the server. In the worst case, connection times may be 5 minutes late.

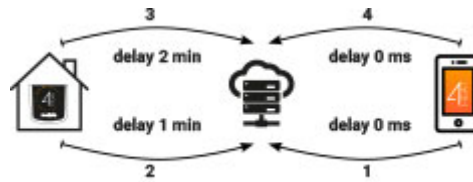

The remote connection can only be used if the user has previously registered in the Cloud Server, see the paragraph: **“CONFIGURAZIONE NUOVO 4HEATMODULE”**

### 3. MECHANICAL SPECIFICATIONS

*Communication ports*

RS232 RS485

*Power supply*

5V

*Housing*

Housing in ABS

*Temperature range*

-20° ÷ 60°

*Fixing*

self-tapping screws 5 mm

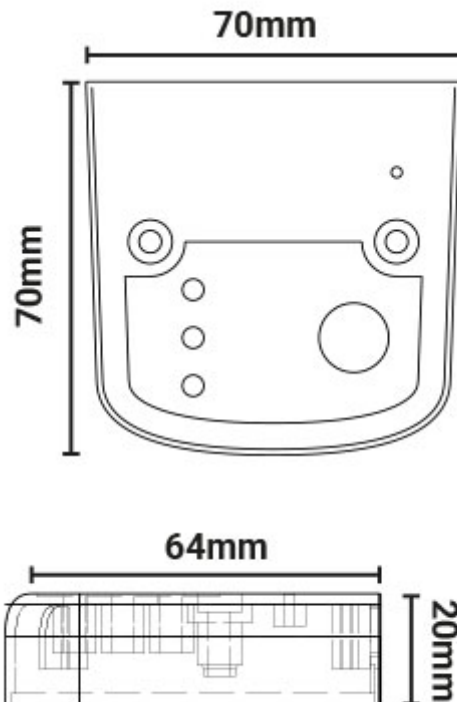

*TiEmme elettronica guarantees the proper functioning of the device of the supplied cables.*

## 4. BUTTONS AND LED

A = Power/error

B = COM Communication

C = Wi-Fi Communication

D = HW reset button



---

## 5. INSTALLATION

1. **Connect the 4HEATMODULE to the power supply:** *the LED (a) must be on and not flashing;*
2. **Connect the 4HEATMODULE to the TiEmme board using the cable supplied in the kit:** *the LED (b) must be on and not flashing, in case of flashing there may be problems communicating with the control board, make sure that the heating system is connected to the mains power supply;*
3. **Wi-Fi communication:** *with LED (c) solid the connection with the APP 4HEAT has been successful and the device is communicating correctly;*
4. **Hardware reset button (d):** *press in case of persistent product malfunction;*

<b>Power</b>	flashing	<i>error</i>
	solid	<i>OK</i>
<b>COM</b>	flashing	<i>not communicating with the control board</i>
	solid	<i>Communication present</i>
<b>Wi-Fi</b>	flashing	<i>Wi-Fi is not configured</i>
	solid	<i>Wi-Fi connected</i>
<b>POWER/ Wi-Fi</b>	flashing	<i>Configuration phase</i>

*If the device is offline during normal operation, press the 4HEAT button for 3 seconds. During configuration and operation, the LEDs can change from solid to flashing light.*

---

## 6. NEW 4HEATMODULE CONFIGURATION

It is recommend to connect your Smartphone to the home Wi-Fi before starting the procedure. At the start, a language must be selected. The configuration procedure is explained below:

- 1. Create an account with a valid email address and a password of your choice.*
- 2. Choose between "ADD DEVICE" and "FIND DEVICE". If the 4HEATMODULE is switched on for the first time, "ADD DEVICE" must be selected.*



3. Follow the procedure. The 4HEATMODULE creates a temporary Wi-Fi to which you must connect with the Smartphone. In this way the Module will be connected to the app and the associated account;

4. Once the app and the 4HEATMODULE are connected, it is required to choose the home Wi-Fi to which the 4HEATMODULE device must connect;

5. Write a name for the device and enter a PIN of your choice. Each 4HEATMODULE device has its own name and password.





If the configuration procedure was not successful, the 4HEATMODULE can be reconfigured by pressing the  button for 8 seconds. After completing the installation procedure of the 4HEATModule, it is advisable to close the app and restart it.

Close the app between open windows in the background.

#### On Apple device:

- Touch the Home button twice
- Scroll up the preview of the 4Heat app to close it.

#### On android devices:

- Press the lower right button for virtual buttons or the lower left button for devices with real buttons
- Scroll to the left to close the 4HEAT app preview.

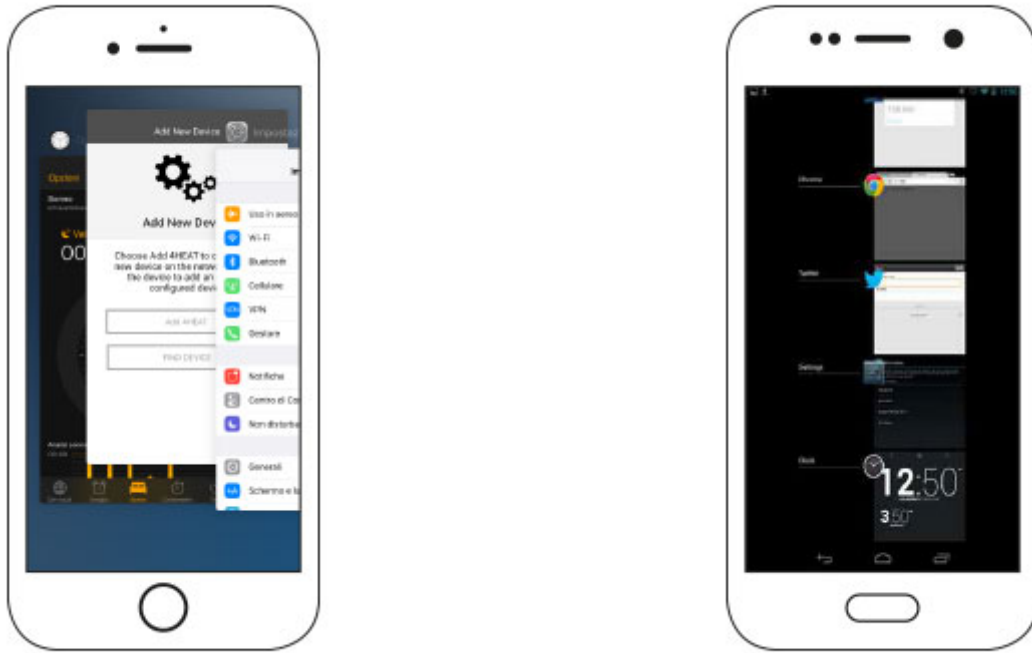





## 7. CONNECTION TO A 4HEATMODULE ALREADY CONFIGURED

In the “FIND DEVICE” section, it is possible to connect to the 4HEATMODULE by entering the PIN code, only if the 4HEATMODULE is connected to the same Wi-Fi as the smartphone. It is also possible to connect remotely (using the data connection of your smartphone) by entering the access credentials of the already configured 4HEATMODULE device.



The Home Page displays the 4HEATMODULE including the temperature and functioning state. The associated 4HEAT devices appear on the Home Page with their identification name.

In the following manner:

-  *Operating status OFF*
-  *Operating status BLOCK*
-  *Operating status ON*
-  *Device not connected or unreachable*
-  *Updating required*

Access to the settings of the associated 4HEAT Module device. ***“SETTING 4HEAT”***



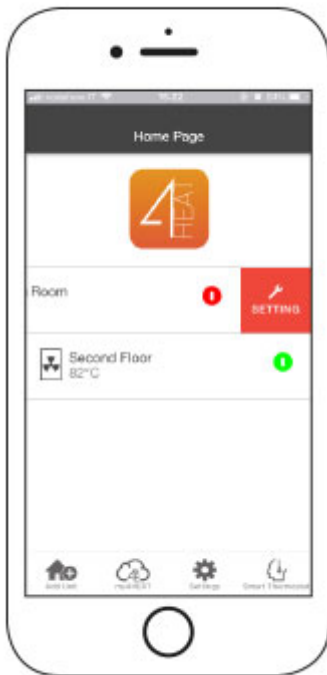

## 8. HOME PAGE



*This menu is used you to configure another 4HEATMODULE device. **“NEW CONFIGURATION 4HEATMODULE”***



*In MY 4HEAT is shown the device credentials associated with your app. Using the button  it is possible to send, via e-mail and messaging services, the data to the 4HEAT applications of other users, in order to share the Heating System management.*



- **Account Management:** menu that allows you to create a new account or log in / out.
- **Restore App:** allows you to reset the app to the default conditions.
- **Re-enable Tutorial:** allows you to re-enable the app tutorial tutorial.
- **Notifications Management:** allows you to enable notifications of the heating system status.
- **Change Language:** allows you to set the app language.
- **Info App:** allows you to view information about the version of the installed app on your smartphone.
- **Download Instruction:** allows you to download the user manual of the app. Press the save icon to store the manual in the internal memory of the smartphone.



*It allows you to connect to the following smart thermostats installed in your home by entering the credentials of registered accounts during the configuration of the same.*

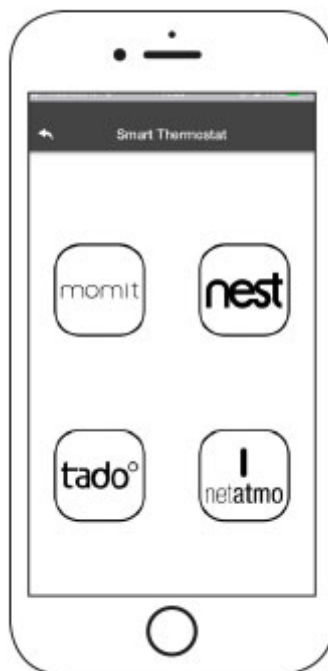



## 9. SETTING 4HEAT

Access to the settings menu of the selected 4HEATMODULE .

- **Device Name:** use to change the name of the current device;
- **Icon:** change the unit display icon on the home page;
- **Remote Assistance Activation:** the user enables the possibility to receive remote technical assistance;
- **Widget:** allows you to select the Widgets that appear on the main device management screen;
- **Settings menu:** allows you to customize the display of menu functions. Some features may not be available due to the configuration of the heating system. "MENU PAGE" at page 23;
- **Settings Info:** allows you to customize the display of the system values of the info menu. "INFORMATION PAGE" at page 22
- **Remove Device:** allows to delete the currently selected device;
- **Weather Modification:** the local weather, which appears as a widget, can be set manually by entering the desired latitude and longitude coordinates, or using the GPS of your Smartphone;
- **Info:** technical information concerning the product code of the control board and the firmware version of the Module;
- **Wi-Fi Info:** information about the internet network to which the 4HEATMODULE device is connected.

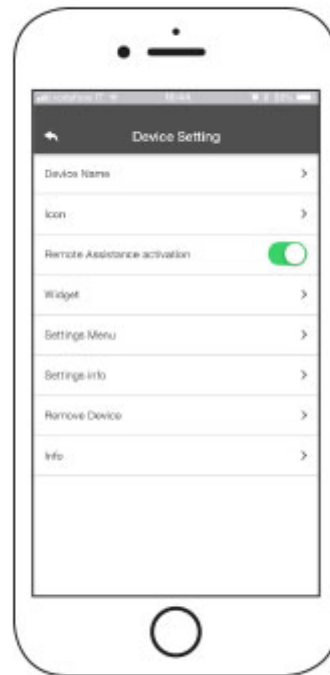

---

## 10. 4HEAT MANAGEMENT

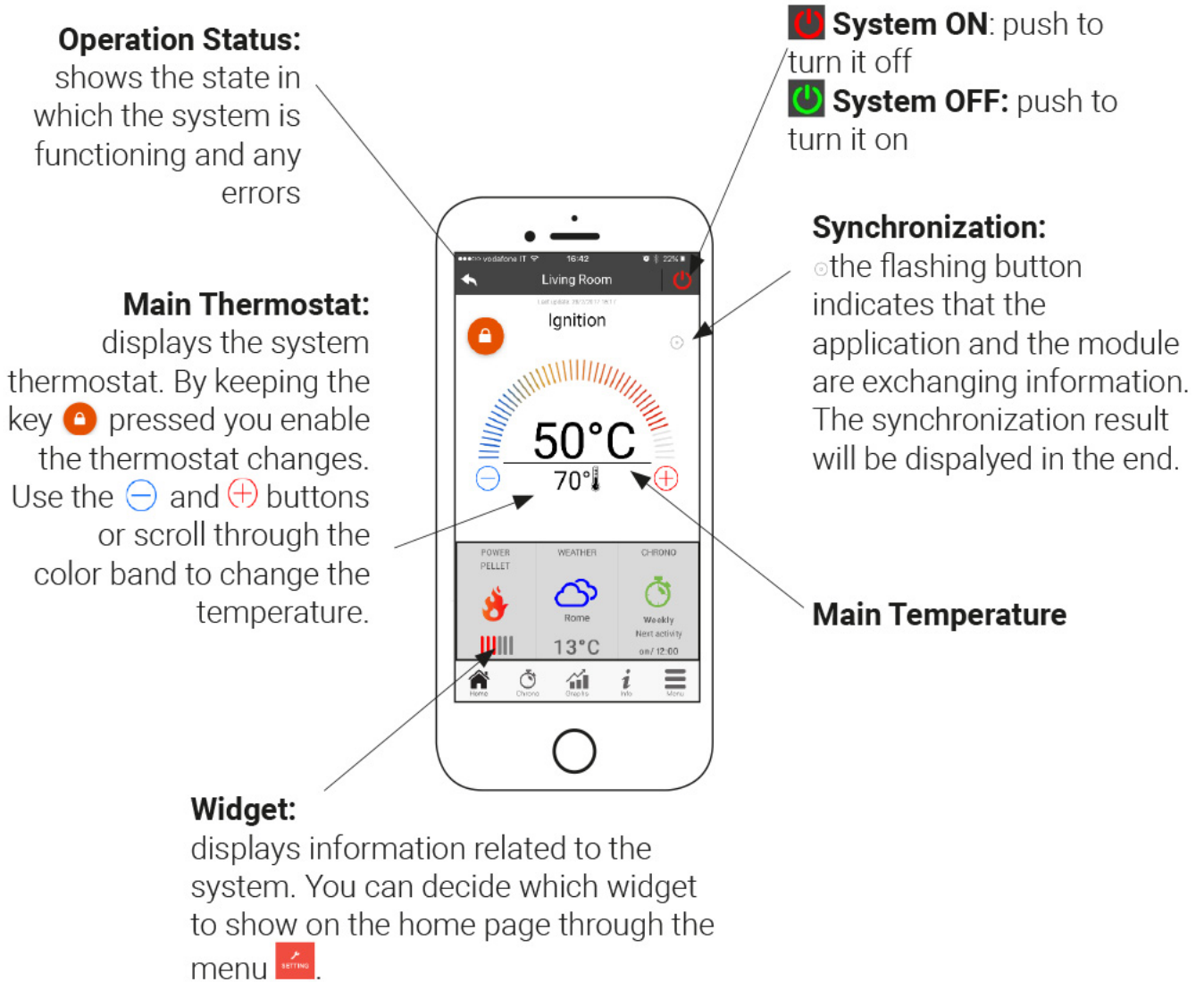

## 11. CHRONO AND 24HEATING FUNCTION

By accessing into the Chrono menu you can set the system management function in two different modes. Pushing on  you can modify the selected modality.

Chrono Modality ON



24HEATING Modality OFF

Entering the **CHRONO** modality you can set 3 different time slots for switching the heating system on and off. You can choose three types of programming:

- **Weekly:** Setting from Monday to Sunday
- **Daily:** Setting up every single day
- **Weekend:** Setting during the weekend (Saturday and Sunday) or during the weekdays (from Monday to Friday).

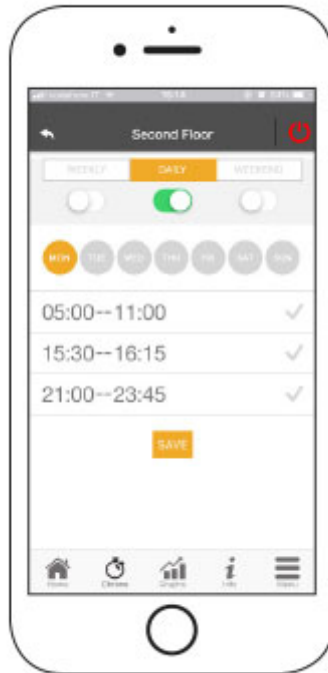

Each time this function is updated, press the Save button that appears at the bottom of the screen. To reset the time slot use the basket that appears with the slide-touch to the right of the time slot.

The **24HEATING** function is a guided procedure to manage the domestic heating by setting the times and temperatures according to daily needs. The wizard asks a few simple questions of the daily routine through which the 24Heating sets the weekly schedule. It is possible to choose the thermostat for the three available time bands:





**24HEATING** allows you to manage time slots also from the main screen:

*Choice and creation of a heating program*

*Management buttons*

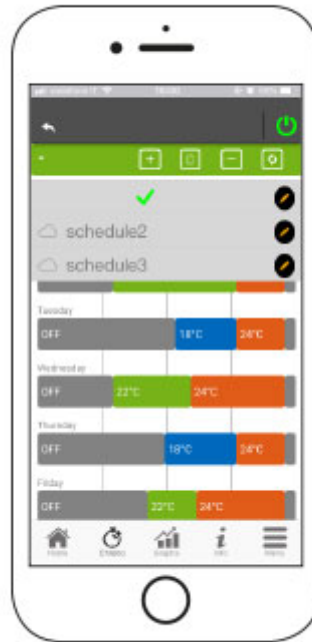
*Time slots created  
by the procedure*



1. **24HEATING program management:** *The drop-down menu at the top of the page shows the programs set by the user. Select the speech bubble to enable the program. Press on the symbol  to change the thermostats of each band.*
2. **Add time slot:** *By selecting the button  you can split a time slot, as shown by the images:*





*By pressing the “+” symbol, it is possible to divide a slot in two, keeping the same settings of the starting slot.*

1. **Elimination of time slot:** *by selecting the button  you can delete a time slot, as shown in the pictures:*



*By pressing the “-” symbol, it is possible to delete the desired time slot.*

1. **Update changes:** *Through the button the  24Heating is synchronized with the device. Be sure to press it each time a change is made*
2. **Copy of a time slot:** *by selecting the button  you can copy the time slots from one day to the another. When finished, press the confirm button at the bottom of the page*



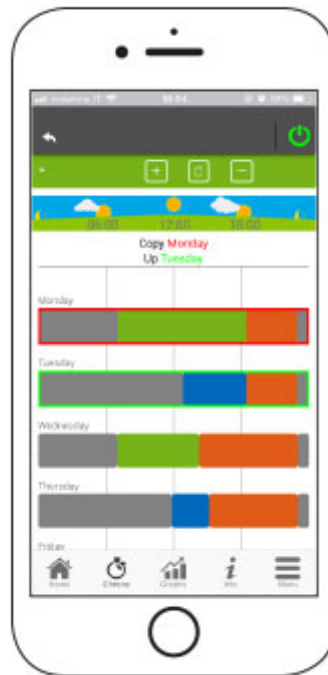

3. **Change of time slot:** *pressing on a time slot you access to the management menu, as indicated by the image:*

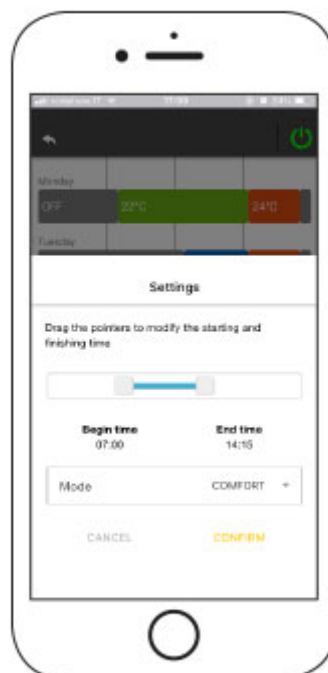

## 12. GRAPH VIEW

This section shows the graphs of the values logged on the server by the 4HEATModule. Two types of views are available:

1. **Daily:** *the displayed values are represented during the daily of operation of the heating system. You can view the graphs of two time slots: 00:00/12:00 or 12:00/00:00. You can also choose to display the operating status of the heating system (ex. Off / Normal / Block etc.). The recorded data is saved for a week.*
2. **Period:** *it is a graphical representation of the system's operating hours based on a week. The recorded data is saved for a year.*



## 13. INFORMATION PAGE

This page displays all the quantities registered by the control board. The quantities to be displayed can be set through the Setting Menu of the selected 4HEATMODULE. **“SETTING 4HEAT”**



You can also view the service provider's reference data and send any support requests via email. If the App is customized for a specific customer, any identification data can be introduced.

---

## 14. MENU PAGE

On the Menu Page, you can access:

- **Power management:** *in this menu it is possible to modify the combustion power and / or the heating power;*
- **Thermostat management:** *allows you to change the main thermostat and other thermostats if required by the heating system functions.*

